

Codice Prodotto <i>Product Code</i>	9.267.054.00	 Fornito Privo di Lubrificante! Supplied without oil!
Descrizione <i>Description</i>	T-27A	

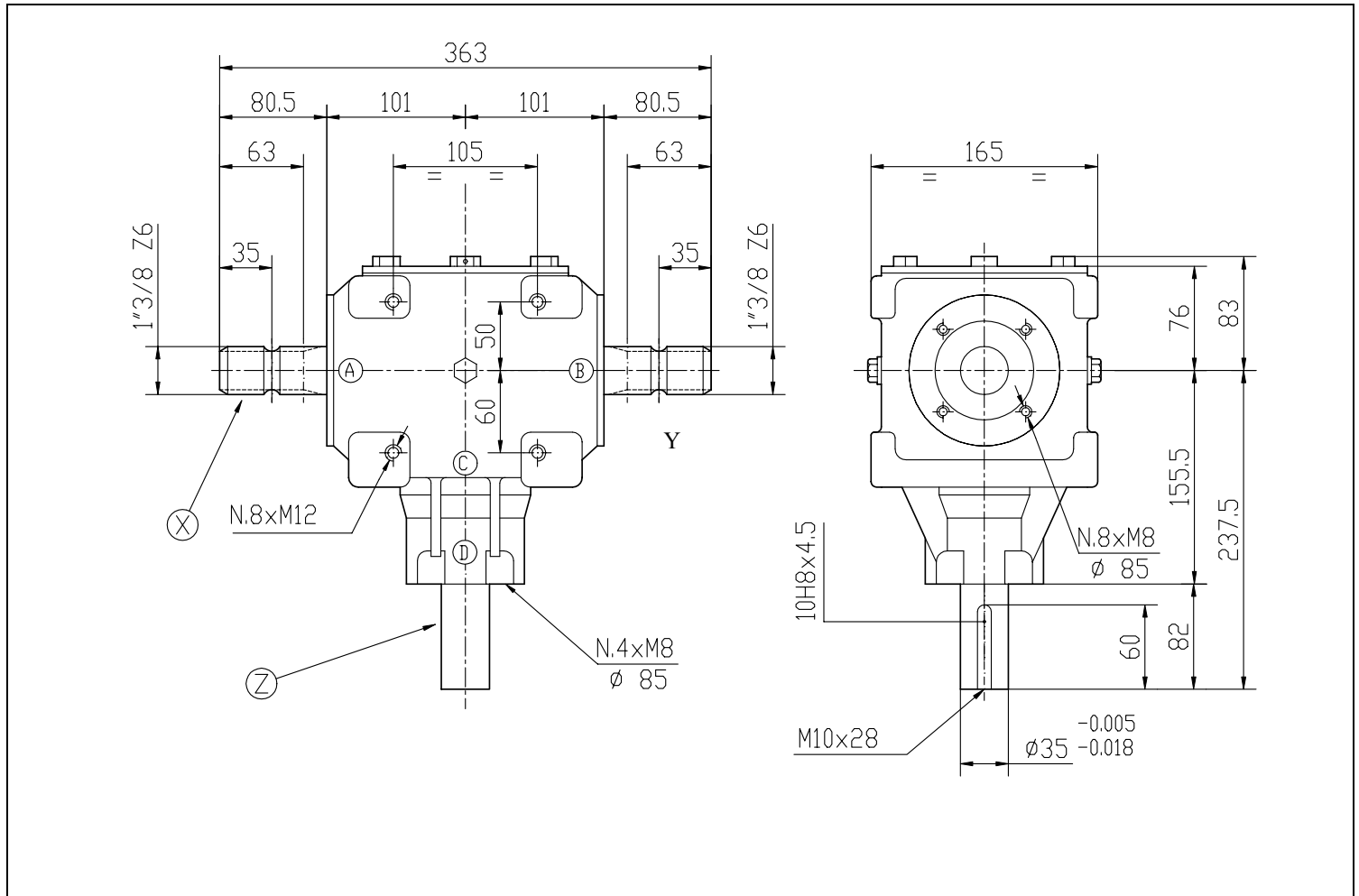
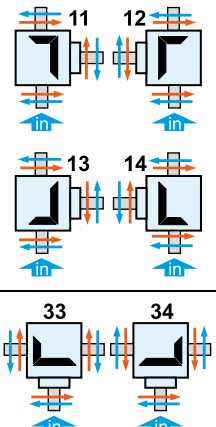

Tipo * Type *	Rapporto Ratio	Giri entrata Input r.p.m.	Potenza entrata Input Power [kW]	Momento Torcente Uscita Output Torque [daNm]	Peso Weight [kg]	Albero Ingresso Input shaft	Sensi di Rotazione Direction of Rotation
R	1,44:1	540	21,3	52,5	21	X-Y	
M	1:1,44	540	27,2	32,4		Z	

* Tipo: M= Moltiplicatore di Giri R= Riduttori di Giri O= Rinvio 1:1 RC= Riduttore Cambio di Velocità RM= Moltiplicatore Cambio di Velocità

* Type: M= Speed Increaser R= Reducer O= Gearbox 1:1 RC= Speed-Change Reducer RM= Speed-Change Increaser